

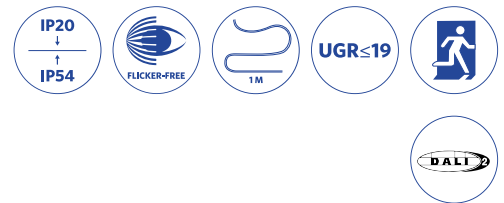

Slim Panel Performer UGR19 G5

- Hochwertiges LED Slim Panel, geeignet für Büros (UGR19)
- Einbau-, Hänge- und Aufbaumontage möglich
- Bis zu 60 % Energieeinsparung im Vergleich zu TL









Artikeldaten

Artikelnummer	Artikelbeschreibung	Ersatz für (W)	Watt (W)	Lumen	Lichtausbeute (lm/W)	CCT (K)	CRI	Gewicht (kg/st)
DALI2								
542004071800	LEDPanelRc-S5 Sq595-34W-DALI-840-U19	TL 4x18W	34	4420	130	4000	≥ 80	2,49

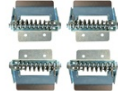
Auf Anfrage erhältlich mit Wieland GST18 oder Wago WINSTA Steckverbindung, oder Schukostecker. Dali2 Ausführung kompatibel mit Zentralenbatterieanlagen laut der Norm EN 50172. BLE-Versionen in Aufbaurahmen können zu einer begrenzten BLE-Signalstärke führen.

Zubehörteile

Aufbaurahmen		Einbaurahmen				
						
140055484 LEDPanelRc-SI Sq600-Surface-Module-WH-CT	542098017600 LEDPanelRc2 Sq600-Surface-Kit-WH	542098009600 LEDPanelRc Sq600-Frame-WH	140057770 LEDPanelRc-SI-Mounting-Springs-595	542098006900 LEDPanel-S4-Suspension-Kit	542098000800 LEDPanelRC-SI U19 EM-kit 1h	
						
140060852 LEDFixture-Ceiling-Cable-Kit-0.5m	542098030700 Junction-Box-WH					
					542098000900 LEDPanelRC-SI U19 EM-kit 3h	

Produkt- und Verpackungsinformationen

Artikel			Verpackung			
Artikel-nummer	Artikelbeschreibung	Commodity Code	Abmessungen (mm) (LxBxH)	Bruttogewicht (kg)	EAN	Stück/Karton
542004071800	LEDPanelRc-S5 Sq595-34W-DALI-840-U19	94051190	661x695x46	3,57	6941497735553	1
140055484	LEDPanelRc-SI Sq600-Surface-Module-WH-CT	94059900	690x690x118	4,26	6956321879808	1
140057770	LEDPanelRc-SI-Mounting-Springs-595	73209090	80x80x53	0,50	6956321888121	1
140060852	LEDFixture-Ceiling-Cable-Kit-0.5m	73121020	100x100x5	0,40	6956321895266	1
542098000800	LEDPanelRC-SI U19 EM-kit 1h	85044082	490x390x150	0,98	6941497702340	1
542098000900	LEDPanelRC-SI U19 EM-kit 3h	85044082	490x390x150	1,08	6941497702333	1
542098001000	LEDTrunking DALI Power Supply	85044082	198x54x39	0,24	6945730496614	1
542098006900	LEDPanel-S4-Suspension-Kit	73121020	130x130x30	0,22	6941497701428	1
542098009600	LEDPanelRc Sq600-Frame-WH	94059900	688x88x694	1,79	6941497704061	1
542098017600	LEDPanelRc2 Sq600-Surface-Kit-WH	94059900	800x330x230	1,53	6941497720696	1
542098030700	Junction-Box-WH	85369010	43x103.4x26	0,06	6941408868684	1

Technische Daten

Lebensdauer (L70)	100.000 h
Lebensdauer (L80)	70.000 h
Lebensdauer (L90)	50.000 h
Ein-/aus-Zyklen	100.000
Farbbeständigkeit (SDCM)	3
Steuerbar	DALI
Abstrahlwinkel	85°
Farbe	Weiß RAL9003
UGR	≤ 19
IP Vorderseite	IP54
IP-Klasse rückseite	IP20
Schlagfestigkeit	IK04
Schutzklasse	II
Risikogruppe (EN 62471)	RG0
Mit Betriebsgerät	Ja
Glühdrahtprüfung	650°C
Treiberfallrate (bei 5.000 Std)	<1 %
Leistungsfaktor	≥ 0,9

Stromversorgung

Frequenz	50/60 Hz
Nennspannung	220-240 V AC
DC input voltage	Siehe Kataloganhang, Anschlußwerte und Gleichstromlichkeit (DC-fähig)
230V Kabellänge	1 m

Material

Werkstoff des Gehäuses	Aluminium
Optisches Material	PMMA
Cover Material	Polystyrol (PS)

Anwendungsmöglichkeiten

Betriebstemperatur	-20-+40°C
Anwendungstemperatur	+25°C
Lagertemperatur	-25-+50°C



ENERGY

OPPLE Lighting
542004071800

A
B
C
D
E
F
G

34
kWh/1000h

2019/2015

Produktmaße (mm)

LEDPanelRc-S5 Sq595

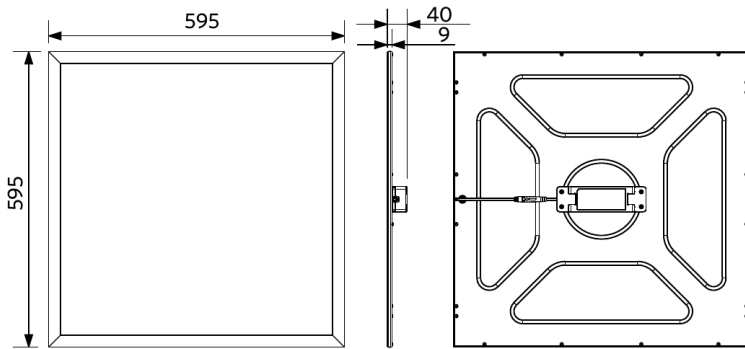

LEDPanelRc-S5
Driver On/Off

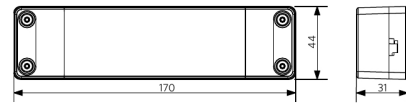

LEDPanelRc-S5
Driver Dim

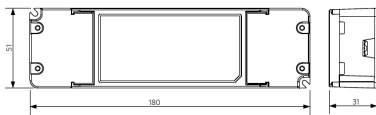

LEDPanelRc-S5
Driver Tunable White

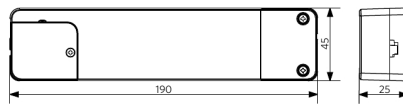

Lichttechnische Daten

